

IT EXPIRES ON JULY 31st 2024



www.gerardi.it

From 6th to 8th
MARCH 2024



ENGLISH

SPECIAL OFFER

**QUICK
CHANGE TABLES**
Reduce downtime
and accelerate
your production

NEW 2024! REQUEST MORE INFORMATION

MODULAR BROACHING DRIVEN TOOLS

Upgrade your CNC Lathe

It creates grooves and internal
cavities directly on the lathe



Go to the Brochure

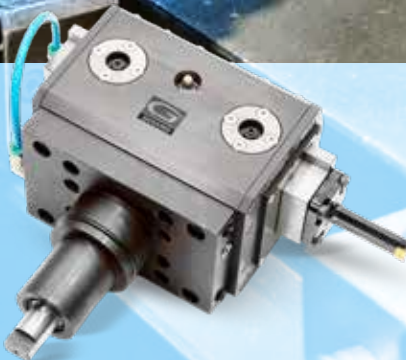

COMPACT GRIP Vises

Self centering vises with reversible jaws - Ideal for 5 axis machining centres

Art.650

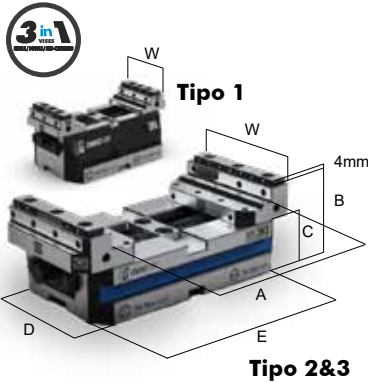

Standard equipment: 1 Box wrench, 1 Calibrated centering, 2 positioning key-nuts and 2 self-centering key-nuts, 2 top jaw inserts Art. 650T G11 pitch 11 mm

+ Magnetic Workstop Art. 370EM

Type	Jaw width W	Max opening A	Vise height B	Base height C	Base width D	Base width E	Kg	Code	LIST PRICE €	SPECIAL PRICE €
1 12kN	50	54	65	45	79,9	80	1,9	7.65.01080	777	649
		94				120	2,7	7.65.01120	897	749
		134				160	3,4	7.65.01160	1.015	849
2 22kN	88	96	65	38	89,9	120	3,6	7.65.02120	955	749
		136				160	4,4	7.65.02160	1.075	849
		176				200	5,2	7.65.02200	1.194	949
		216				240	5,8	7.65.02240	1.314	1.049
3 32kN	123	133	89	57	124,9	160	9,1	7.65.03160	1.552	1.249
		183				210	10,9	7.65.03210	1.790	1.349
		233				260	12,8	7.65.03260	2.029	1.449
		283				310	14,8	7.65.03310	2.387	1.749
		333				360	17	7.65.03360	2.625	1.949

MAXIGRIP

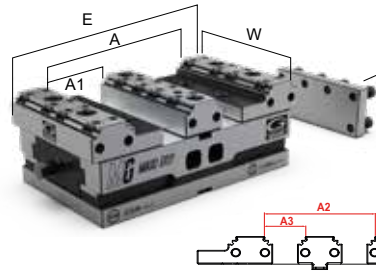

Art.685

MaxiGrip vise - 3 clamping in 1 - Self-Centering, Double and Single

Type	kN	A	A1	A2	A3	W	E	Kg	Code	LIST PRICE €	SPECIAL PRICE €
4x270	41	200	83	104	35	158	270	28,5	76854270	2.920	2.299
4x420		344	155	248	107	420	40	76854420	3.870	3.099	

Art.684

MaxiGrip vise - Only Self-centering

Type	kN	A	A1	A2	A3	W	E	Kg	Code	LIST PRICE €	SPECIAL PRICE €
4x270	41	200	-	104	-	158	270	25	76844270	2.500	1.999
4x420		344	-	248	-	420	36	76844420	3.450	2.799	

RISERS FOR COMPACT GRIP VISES

Art.651H

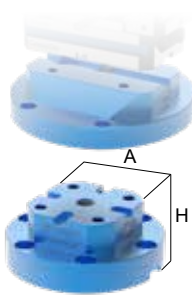

Type	Min A	H=50			H=75			H=100		
		Code	LIST PRICE €	SPECIAL PRICE €	Code	LIST PRICE €	SPECIAL PRICE €	Code	LIST PRICE €	SPECIAL PRICE €
1	80	7.65.1H1080/050	414	350	7.65.1H1080/075	425	350	7.65.1H1080/100	437	350
	120	7.65.1H1120/050	492	400	7.65.1H1120/075	517	400	7.65.1H1120/100	539	400
	160	7.65.1H1160/050	588	450	7.65.1H1160/075	620	500	7.65.1H1160/100	654	500
2	120	7.65.1H2120/050	588	450	7.65.1H2120/075	620	500	7.65.1H2120/100	654	500
	160	7.65.1H2160/050	588	500	7.65.1H2160/075	620	550	7.65.1H2160/100	654	550
	200	7.65.1H2200/050	588	550	7.65.1H2200/075	620	600	7.65.1H2200/100	654	600
	240	7.65.1H2240/050	727	600	7.65.1H2240/075	773	600	7.65.1H2240/100	820	650
3	160	7.65.1H3160/050	680	650	7.65.1H3160/075	726	650	7.65.1H3160/100	769	650
	210	7.65.1H3210/050	680	650	7.65.1H3210/075	726	700	7.65.1H3210/100	769	700
	260	7.65.1H3260/050	1.047	950	7.65.1H3260/075	1.106	950	7.65.1H3260/100	1.167	950
	310	7.65.1H3310/050	1.085	1.000	7.65.1H3310/075	1.146	1.000	7.65.1H3310/100	1.207	1.000
	360	7.65.1H3360/050	1.255	1.100	7.65.1H3360/075	1.326	1.100	7.65.1H3360/100	1.398	1.100

PYRAMIDAL SUPPORT FOR 5TH AXIS CENTRES - INCLUDED MOUNTED & ALIGNED VISES

Art.643H



Standard equipment: 12 Vise holding clamps Art.298 CGR, 1 Eyebolt, 1 Centering pin, Pair of keynuts Art.297

+ MOUNTING & ALIGNEMENT INCLUDED

Aluminum pyramidal support, it permits the simultaneous mounting of 3 CompactGrip vises (with or without quick change tables) tilted at 45° or 60° thus increasing the working space and allowing the contemporary machining of multiple workpieces even in hardly reachable points.

Type	Height	Code	LIST PRICE €
1 (Ø200)	170	7.64.3H100	1.763
2 (Ø308)	136	7.64.3H200	2.157
3 (Ø360)	190	7.64.3H300	2.314

KIT 1

Art. 643H + N°3 Art.650 T.1x120



60°

Code	LIST PRICE €	SPECIAL PRICE €
7.65.01120	4.373	3.400

KIT 2

Art. 643H + N°3 Art.650 T.2x200



30°

45°

* Check the machine spindle turning

Code	LIST PRICE €	SPECIAL PRICE €
7.65.02200	5.571	4.200

KIT 3

Art. 643H + N°3 Art.650 T.3x210



45°

* Check the machine spindle turning

Code	LIST PRICE €	SPECIAL PRICE €
7.65.03210	7.525	5.300



SCAN IT
TO WATCH
THE VIDEO
PRESENTATION



Quick change PLATES

Quick change plates for compactgrip vises - Ideal for 5 axis machines

* NOT AVAILABLE FOR THE GERMAN AND AUSTRIAN MARKET

Art.660

Mechanical quick change rectangular table

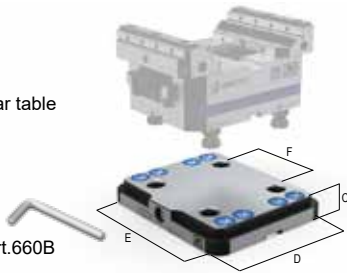

Standard equipment: 4 Pull-studs Art.660B

Type	C	D	E	Kg	Code	LIST PRICE €	SPECIAL PRICE €
1-2 (F=52)	27	116	150	3	9.66.05200	787	649
3 (F=96)	27	156	190	5,2	9.66.09600	1.133	949

Art.661

Mechanical quick change round table

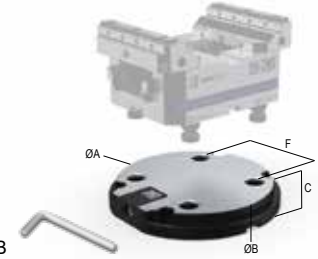

Standard equipment: 4 Pull-studs Art.660B

Type	ØA	ØB	C	Kg	Code	LIST PRICE €	SPECIAL PRICE €
1-2 (F=52)	156	120	27	3	9.66.15200	754	649
3 (F=96)	196	175	27	5,2	9.66.19600	1.102	949

Art.660S

Mechanical quick change hardened with machineable part holes free rectangular table

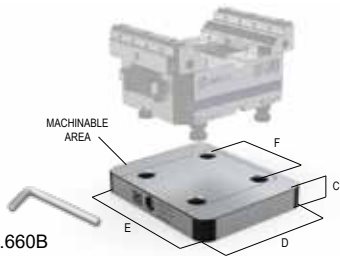

Customization excluded

Standard equipment: 4 Pull-studs Art.660B

Type	C	D	E	Kg	Code	LIST PRICE €	SPECIAL PRICE €
1-2 (F=52)	27	126	150	3	9.66.0S520	638	549
3 (F=96)	27	156	190	5,2	9.66.0S960	870	749

Art.661S

Mechanical quick change hardened with machineable part holes free round table

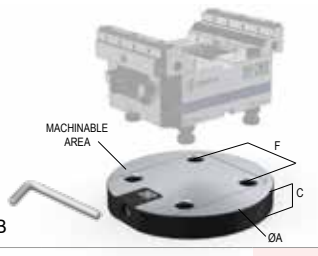

Available Quick Change Tables for any kind of Rotary Tables or 4° Axis

Customization excluded

Standard equipment: 4 Pull-studs Art.660B

Type	ØA	C	Kg	Code	LIST PRICE €	SPECIAL PRICE €
1-2 (F=52)	156	27	3,8	9.66.1S5200	696	549
3 (F=96)	196	27	6	9.66.1S9600	1.159	749
	250	24	10	9.66.1S960-250	1.647	1.550
	300	24	15	9.66.1S960-300	1.750	1.650

Art.660R

Mechanical quick change rectangular reduction table

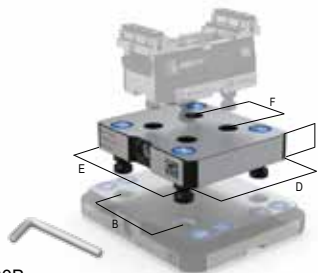

Standard equipment: 4 Pull-studs Art.660B

Type	B	C	D	E	Kg	Code	LIST PRICE €	SPECIAL PRICE €
F = 52	96	27	126	150	3,75	9.66.0R210	696	549

Art.661R

Round reduction table



Standard equipment: 4 Pull-studs Art.660B

Type	A	B	C	Kg	Code	LIST PRICE €	SPECIAL PRICE €
F = 52	158	96	27	3,75	9.66.1R210	870	549

Art.660B

Quick change table pull studs



For type 1-2 tables

For type 3 tables

Type	Code	LIST PRICE CAD. €
1 - 2	9.66.0B100	31
3	9.66.0B200	33

Art.661H

Aluminium base riser for quick-change table, can be mounted with brackets or via Zero Point



Art.661S

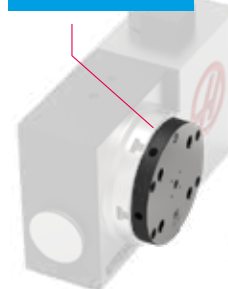

Rotary Table Haas Hrt200

Pull Stud Art.660B

Self centering Chuck

Interfaced plate Art.62B

EXAMPLE
Mounting of a round quick change table for CompactGrip vises

CompactGrip vises Art.650 T.3

STANDARD FLEX Vises

Innovative comb system for quick pull-down jaw plates change - Ideal for vertical machining centres

Art.1A

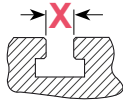

Std Equipment: 1 workstop, 2 positioning key-nuts for 16 mm slot, 2 inserts Art. 291, 1 box wrench, 1 "T" wrench

+ 4 Holding Clamps Art.298

StandardFLEX series
precision modular vise

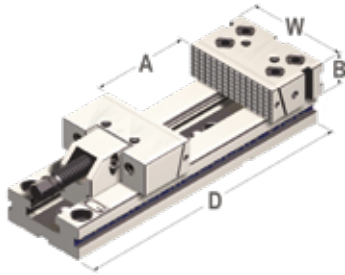

Type	Max opening A	Jaw width W	Jaw Height B	Base Length D	Code	LIST PRICE €	SPECIAL PRICE €
2 25kN	150	121 mm	38	345	1.1A.20000	925	789
	200	146 mm	48	420	1.1A.32000	1.112	839
3 30kN	300			520	1.1A.33000	1.283	949
	200			455	1.1A.42000	1.414	1.189
4 30kN	300	171 mm	58	555	1.1A.43000	1.555	1.239
	400			655	1.1A.44000	1.696	1.339
5 40kN	200			495	1.1A.52000	1.846	1.489
	300	196 mm	63	595	1.1A.53000	2.210	1.789
	400			695	1.1A.54000	2.582	2.039

REDUCTION UP TO 20%

* When bought with a complete vise

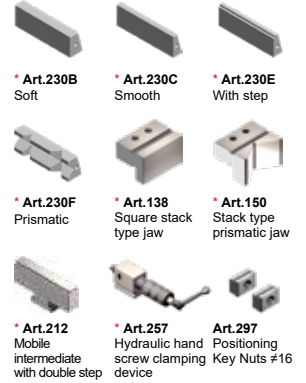

EXTRA LONG Vises

Vises with the extra large base dimension, much longer than std vises - Ideal for vertical machining centres

Art.21

(Single Clamping)

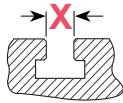

Std Equipment: 1 workstop, 2 positioning key-nuts for 16 mm slot, 2 inserts Art. 291, 1 box wrench, 1 "T" wrench

+ 6 Holding clamps Art. 298

XL modular vise
with standard dotation

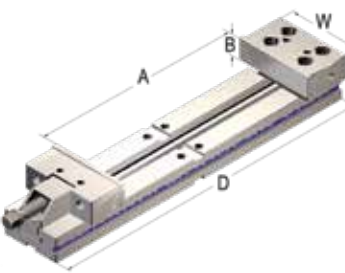

Type	Max opening A	Jaw width W	Jaw Height B	Base Length D	Kg	Code	LIST PRICE €	SPECIAL PRICE €
2 25kN	320	125 mm	40	520	17	2.21.23200	1.147	800
	360			580	32	2.21.33600	1.425	1.000
3 30kN	460	150 mm	50	680	35	2.21.34600	1.578	1.150
	500			766	52	2.21.45000	1.828	1.350
4 30kN	600	175 mm	60	866	56	2.21.46000	1.990	1.450
	700			966	61	2.21.47000	2.159	1.550

REDUCTION UP TO 20%

* When bought with a complete vise

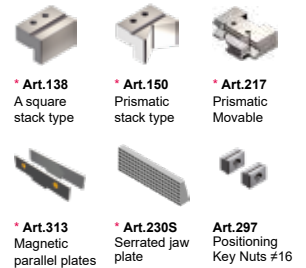

Parallel MAGNETIC PLATES

Wide range of heights available on page 4.27 - General price list w17

REDUCTION UP TO 40%

FOR VISES STANDARD & STANDARDFLEX ART.1 e ART.1A

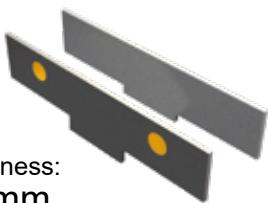

Thickness:
2,8mm

Art.414

Also Available
Universal Parallel
magnetic plates



Type	Pair of guided parallels magnetic plates	LIST PRICE EACH €	Art.310		Art.311	
			PRICE EACH €	KIT PRICE €	PRICE EACH €	KIT PRICE €
1		73	50	300	-	-
2		93	65	390	-	-
3		116	75	450	70	700
4		136	90	540	80	800
5		155	100	600	90	900
6		176	120	720	100	1.000



AUTOMATION Kits

Unit with pneumatic control and single effect cylinder - Ideal for vertical machining centres

FOR VISES STANDARD & STANDARDFLEX ART.1 e ART.1A

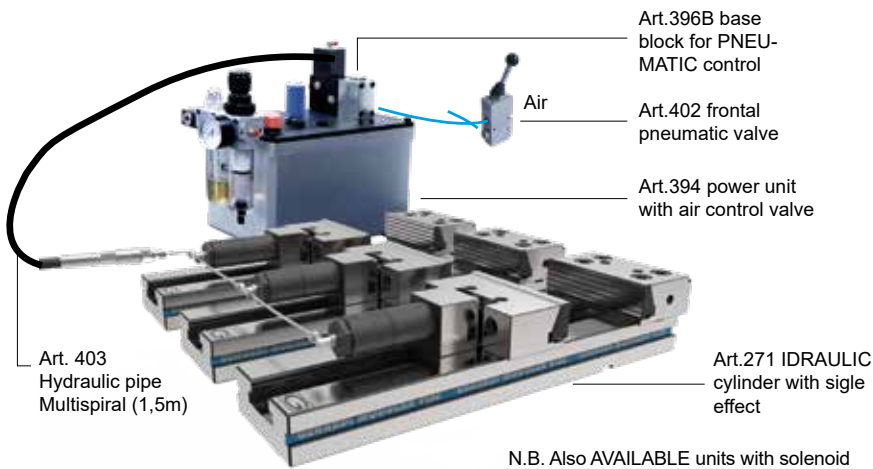

N.B. Also AVAILABLE units with solenoid valves electromagnetics FOR CNC

WISE NOT INCLUDED

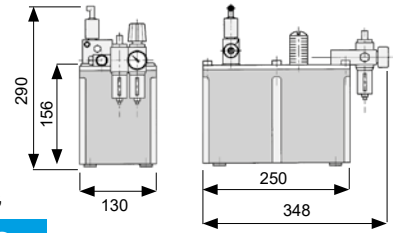

N°1 CLAMPING

Art.392

Type	Stroke Art.271	Code	LIST PRICE €	SPECIAL PRICE €
2	26	4.39.22000	1.872	1.499
3		4.39.23000	1.884	1.499
4		4.39.24000	1.917	1.499
5	40	4.39.25000	2.109	1.599

*Art.405H Suitable galvanized steel pipe Ø6 (m1,0)
(Not included) Codice: 4.40.5H000

SIMULTANEOUS VISES CLAMPING KIT

Art.392/2

(Art.271- 394 - 402 - 403)
N°2 SYMULTANEOUSLY CLAMPING
Art.392 + N°1 Art.271

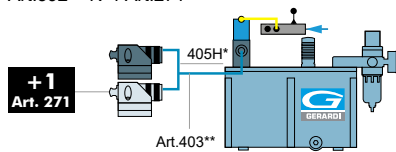

Type	Code	LIST PRICE €	SPECIAL PRICE €
2	4.39.22002	2.255	1.799
3	4.39.23002	2.277	1.799
4	4.39.24002	2.345	1.799
5	4.39.25002	2.725	2.099

Art.392/3

N°3 SYMULTANEOUSLY CLAMPING
Art.392 + N°2 Art.271

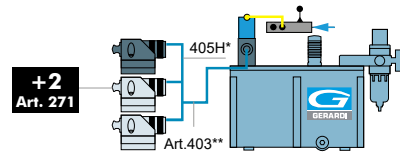

Type	Code	LIST PRICE €	SPECIAL PRICE €
2	4.39.22003	2.634	2.099
3	4.39.23003	2.667	2.099
4	4.39.24003	2.767	2.099
5	4.39.25003	3.341	2.499

Art.392/4

N°4 SYMULTANEOUSLY CLAMPING
Art.392 + N°3 Art.271

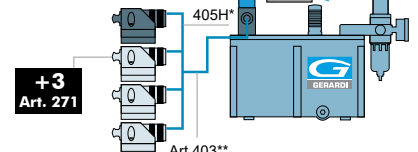

Type	Code	LIST PRICE €	SPECIAL PRICE €
2	4.39.22004	3.017	2.399
3	4.39.23004	3.059	2.399
4	4.39.24004	3.196	2.399
5	4.39.25004	3.958	2.999

INDEPENDENT CLAMPING GROUP KIT

Art.392A/2

(Art.271- 394 - 402 - 403)
N°2 SYMULTANEOUSLY CLAMPING
Art.392 + N°1 Art.407B

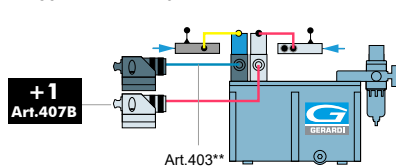

Type	Code	LIST PRICE €	SPECIAL PRICE €
2	4.39.2A202	3.063	2.399
3	4.39.2A302	3.083	2.399
4	4.39.2A402	3.161	2.399
5	4.39.2A502	3.639	2.799

Art.392A/3

N°3 SYMULTANEOUSLY CLAMPING
Art.392 + N°2 Art.407B

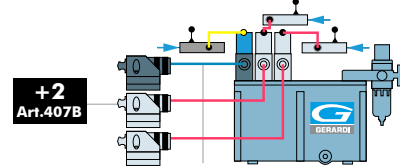

Type	Code	LIST PRICE €	SPECIAL PRICE €
2	4.39.2A203	3.564	2.799
3	4.39.2A303	3.596	2.799
4	4.39.2A403	3.695	2.799
5	4.39.2A503	4.247	3.299

Art.392A/4

N°4 SYMULTANEOUSLY CLAMPING
Art.392 + N°3 Art.407B

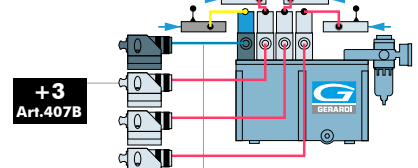

Type	Code	LIST PRICE €	SPECIAL PRICE €
2	4.39.2A204	4.413	3.599
3	4.39.2A304	4.455	3.599
4	4.39.2A404	4.584	3.599
5	4.39.2A504	5.319	4.199

*Art.403 (Included) Hydraulic pipe Multispiral 760bar complete with rapid connection Art. 270A (m 1,5) Codice: 4.40.30000

FMS Vises

For single, double and self-centering clamping - Ideal for vertical & horizontal machines

Art.855

Base Body 3 in 1

Art.855A

Base Body
Self-Centering Only

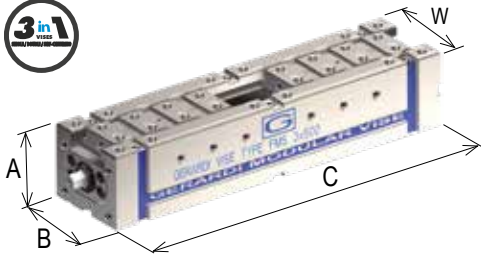

Type	Base eight A	Base width B	Base length C	Code	LIST PRICE €	Code	LIST PRICE €
2 (94mm) 25kN	90	95	400	5.85.52400	1.365	5.85.52400A	1.447
			500	5.85.52500	1.848	5.85.52500A	1.947
			600	5.85.52600	2.041	5.85.52600A	2.114
3 (124mm) 30kN	100	125	500	5.85.53500	1.773	5.85.53500A	1.864
			600	5.85.53600	2.452	5.85.53600A	2.559
4 (144mm) 30kN	120	145	600	5.85.54600	2.258	5.85.54600A	2.337

COMPOSE YOUR VISE WITH THE HUNDREDS OF JAWS AVAILABLE

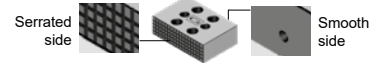

DOUBLE CLAMPING CONFIGURATION

Art.860

Double vises with serrated jaws

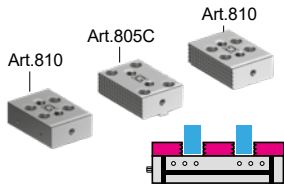

Type	Code	LIST PRICE €	SPECIAL PRICE €
2	5.86.02400	1.794	1.400
	5.86.02500	2.281	1.800
	5.86.02600	2.471	1.950
3	5.86.03500	2.264	1.800
	5.86.03600	2.941	2.300
4	5.86.04600	2.908	2.300

Art.863

Double vise with step jaws

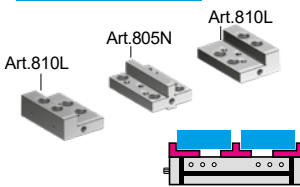

Type	Code	LIST PRICE €	SPECIAL PRICE €
2	5.86.32400	1.952	1.550
	5.86.32500	2.436	1.900
	5.86.32600	2.628	2.100
3	5.86.33500	2.420	1.900
	5.86.33600	3.098	2.450
4	5.86.34600	3.104	2.450

Art.865

Double vise with quick change pull down jaws (comb system)

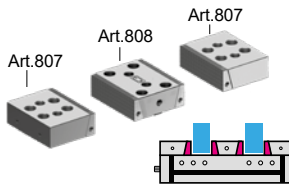

Type	Code	LIST PRICE €	SPECIAL PRICE €
2	5.86.52400	2.120	1.700
	5.86.52500	2.604	2.100
	5.86.52600	2.798	2.200
3	5.86.53500	2.735	2.200
	5.86.53600	3.418	2.700
4	5.86.54600	3.540	2.800

Art.866

Double vise with floating step jaws (3x5)

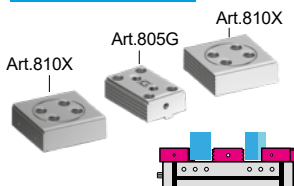

Type	Code	LIST PRICE €	SPECIAL PRICE €
2	5.86.02400	2.242	1.800
	5.86.02500	2.728	2.200
	5.86.02600	2.918	2.300
3	5.86.03500	2.761	2.200
	5.86.03600	3.439	2.700
4	5.86.04600	3.391	2.700

Art.867

Double vise with floating step jaws with adjustable inserts

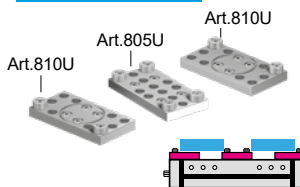

Type	Code	LIST PRICE €	SPECIAL PRICE €
2	5.86.72400	2.618	1.999
	5.86.72500	3.048	2.328
	5.86.72600	3.293	2.516
3	5.86.73500	3.171	2.423
	5.86.73600	3.850	2.941
4	5.86.74600	3.874	2.960

* SELF-CENTERING CONFIGURATION ONLY

* For self-centering configuration ONLY, spacer Art.850T included in the price

Art.855A

Base Body -
Self-Centering Only

Art.810

2 Serrated jaws

Art.860A

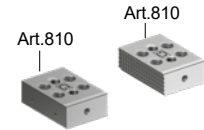

Type	* LIST PRICE €
2	1.647
	2.135
	2.325
	2.100
3	2.776
	2.682

Art.855A

Base Body -
Self-Centering Only

Art.810L

2 Step jaws

Art.863A

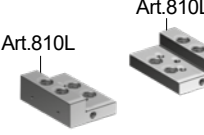

Type	* LIST PRICE €
2	1.722
	2.206
	2.398
	2.172
3	2.848
	2.775

Art.855A

Base Body -
Self-Centering Only

Art.807

2 Quick change
pull down jaws

Art.865A

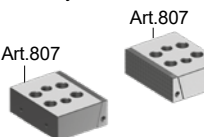

Type	* LIST PRICE €
2	1.846
	2.330
	2.524
	2.332
3	3.015
	3.008

Art.855A

Base Body -
Self-Centering Only

Art.814 (n°2)

Art.805V (n°2)

Art.868A

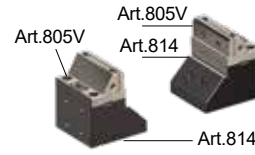

Type	* LIST PRICE €
2	2.113
	2.578
	2.757
	2.590
3	3.246
	3.328

Art.855A

Base Body -
Self-Centering Only

Art.810J

2 Prismatic jaws

Art.870A

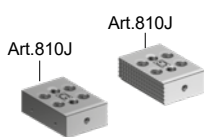

Type	* LIST PRICE €
2	1.882
	2.367
	2.558
	2.377
3	3.054
	3.108

IDEAL FOR 5 AXIS MACHINING CENTRES

MULTIFLEX Vises

For multiple clamping from 1 to 19 workpieces of various sizes - Ideal for vertical & horizontal machines



Std Equipment : 1 "T" wrench, 2 positioning keynuts and 4 workstops. Each vise is supplied for 4 workpieces clamping.

+ 6 holding clamps Art.298

(* Types supplied for 3 workpieces clamping)

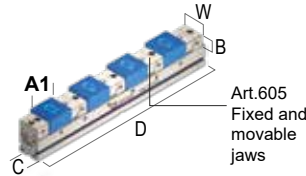

Art.605 Fixed and movable jaws

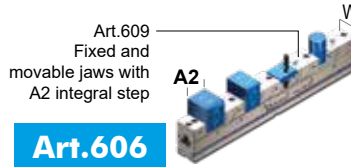

Art.609 Fixed and movable jaws with A2 integral step

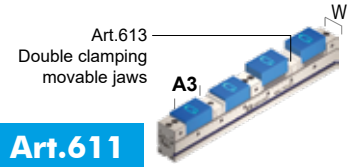

Art.613 Double clamping movable jaws

Art.600

Art.600W

Art.606

Art.611

Type	B	C ^{+0/-0.02}	D	W	A1 mm	Code	LIST PRICE €	SPECIAL PRICE €	A2 mm	Code	LIST PRICE €	SPECIAL PRICE €	A3 mm	Code	LIST PRICE €	SPECIAL PRICE €
1 20kN	32/25	50	49	4x8	6.60.01300	1.204	749	* 3x19	6.60.61300	1.822	1.200	* 3x21	6.61.11300	1.822	1.200	
				4x33	6.60.01400	1.308	849	4x23	6.60.61400	1.898	1.300	4x46	6.61.11400	1.898	1.300	
				4x58	6.60.01500	1.425	949	4x48	6.60.61500	2.013	1.400	4x71	6.61.11500	2.013	1.400	
				4x83	6.60.01600	1.553	1.049	4x73	6.60.61600	2.141	1.500	4x96	6.61.11600	2.130	1.500	
				4x108	6.60.01700	1.736	1.149	4x97	6.60.61700	2.327	1.600	4x121	6.61.11700	2.327	1.600	
2 30kN	40	75	74	4x12	6.60.02400	1.566	1.099	* 3x28	6.60.62400	2.266	1.550	4x34	6.61.12400	2.266	1.550	
				4x37	6.60.02500	1.681	1.249	4x24	6.60.62500	2.386	1.650	4x59	6.61.12500	2.386	1.650	
				4x62	6.60.02600	1.811	1.349	4x49	6.60.62600	2.517	1.750	4x84	6.61.12600	2.517	1.750	
				4x87	6.60.02700	1.940	1.449	4x74	6.60.62700	2.647	1.850	4x109	6.61.12700	2.647	1.850	
				4x112	6.60.02800	2.114	1.549	4x99	6.60.62800	2.832	1.950	4x134	6.61.12800	2.832	1.950	
3 40kN	60	100	99	4x137	6.60.02900	2.302	1.749	4x124	6.60.62900	3.021	2.050	4x158,5	6.61.12900	3.021	2.050	
				4x59	6.60.03700	2.244	1.649	4x44	6.60.63700	3.057	2.150	4x77	6.61.13700	3.057	2.150	
				4x84	6.60.03800	2.428	1.749	4x69	6.60.63800	3.245	2.250	4x102	6.61.13800	3.245	2.250	
				4x109	6.60.03900	2.619	1.949	4x94	6.60.63900	3.431	2.450	4x127	6.61.13900	3.431	2.450	
				4x134	6.60.03100	2.869	2.149	4x119	6.60.63100	3.682	2.650	4x152	6.61.13100	3.682	2.650	

FOR MAGNETIC PARALLEL PLATES AND PARALLEL JAW PLATES

Art.616
Pair of magnetic parallel plates for Art. 600

REDUCTION UP TO
20%

When bought with a complete vise



Art.610E
Parallel jaw plate for Art.606

REDUCTION UP TO
20%

When bought with a complete vise

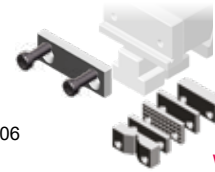

MULTITASKING Vises

Self-centering and eccentric vises - Ideal for 5 axis machining centres

Art.640

Possible request of 2 Art.645T jaws instead Art.645E

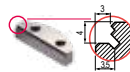

Standard equipment : 1 workstop, 1 exagonal wrench, pair of positioning key-nuts Art.297, 1 straight pin Art.640P

Type	1	2	3x166	3x266
Code	6.64.01000	6.64.02000	7.64.03166	7.64.03266
LIST PRICE €	1.858	2.285	2.658	2.785
SPECIAL PRICE €	1.049	1.249	2.039	2.124



Simple riser for Art.640 vise
MOUNTING INCLUDED

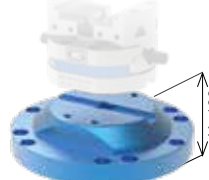

Steel risers with zero point for Art.640 for quick change. Standard equipment : 1 pull-stud Art.10S / 11S 1 teflon cap with O-ring Art.9, 1 positioning pin Art.640P, 1 shoulder calibrated screw Art.79

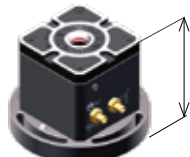

Art.645B
Soft Jaw



Art.645C
Smooth Jaw



Art.645D
Serrated Jaw



Art.645E
Step Jaw



Art.645F
Prismatic Jaw



Art.645T
Grip Jaw



Type	Code	LIST PRICE €	SPECIAL PRICE €
1	6.64.5B100	102	77
2	6.64.5B200	122	93
3	6.64.5B300	159	121

Type	Code	LIST PRICE €	SPECIAL PRICE €
1	6.64.5C100	102	77
2	6.64.5C200	122	93
3	6.64.5C300	159	121

Type	Code	LIST PRICE €	SPECIAL PRICE €
1	6.64.5D100	102	77
2	6.64.5D200	122	93
3	6.64.5D300	159	121

Type	Code	LIST PRICE €	SPECIAL PRICE €
1	6.64.5E100	115	87
2	6.64.5E200	134	102
3	6.64.5E300	171	130

Type	Code	LIST PRICE €	SPECIAL PRICE €
1	6.64.5F100	129	98
2	6.64.5F200	146	111
3	6.64.5F300	185	141

Type	Code	LIST PRICE €	SPECIAL PRICE €
1	6.64.5T100	129	98
2	6.64.5T200	146	111
3	6.64.5T300	185	141

TOMBSTONES

Solid cast iron cast with double stress relieving heat treatment - Ideal for orizontal machining centres made in italy

STANDARD JAPANESE

Art.53B

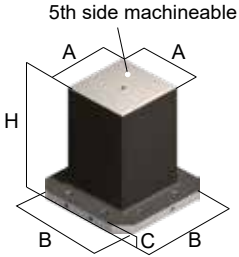

Code	A	B	C	D	H	Kg	LIST PRICE €	SPECIAL PRICE €
8.53.B00080	260	400	45	-	550	197	1.853	1.550
8.53.B00081	260	400	45	-	660	228	2.139	1.690
8.53.B00100	260	500	45	-	650	255	2.417	2.000
8.53.B00105	260	500	45	-	750	284	2.505	2.000
8.53.B00115	310	500	45	-	900	383	3.551	2.700
8.53.B00171	360	500	45	-	700	356	3.328	2.500
8.53.B00180	360	630	45	-	820	452	4.217	3.200
*8.53.B00211	510	630	45	-	860	61	5.858	3.850

* Only for pallets with "T" slots

Art.53B2 PLUS

Code	Kg	LIST PRICE €	SPECIAL PRICE €
8.53.B20080	182	2.361	1.950
8.53.B20081	204	2.680	2.050
8.53.B20100	238	3.027	2.400
8.53.B20105	254	3.138	2.500
8.53.B20115	354	4.311	3.300
8.53.B20171	326	4.041	3.050
8.53.B20180	427	5.277	4.200
8.53.B20211	593	7.113	4.350

Art.55B

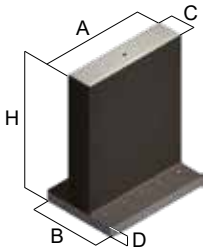

Code	A	B	C	D	H	Kg	LIST PRICE €	SPECIAL PRICE €
8.55.B00052	410	400	160	50	660	244	2.345	1.800
8.55.B00053	510	500	160	50	700	331	3.131	2.400
8.55.B00054	510	500	210	55	600	316	3.042	2.300
8.55.B00170	640	450	160	55	820	460	4.347	3.200
8.55.B00172	640	630	210	55	850	545	5.178	3.540
8.55.B00190	810	450	160	65	800	604	5.805	4.040

Art.55B2 PLUS

Code	Kg	LIST PRICE €	SPECIAL PRICE €
8.55.B20052	206	2.846	2.150
8.55.B20053	303	3.801	2.900
8.55.B20054	301	3.693	2.800
8.55.B20170	433	5.278	4.000
8.55.B20172	520	6.288	4.500
8.55.B20190	782	7.048	4.900

Art.57B

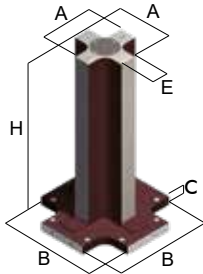

Code	A	B	C	D	H	Kg	LIST PRICE €	SPECIAL PRICE €
8.57.B00100	210	500	50	80	750	157	1.715	1.550
8.57.B00110	280	500	50	80	850	235	2.126	1.950
8.57.B00120	240	500	50	110	850	218	2.049	1.850
8.57.B00130	310	500	50	150	850	269	2.466	2.050
8.57.B00140	310	630	50	150	950	327	2.790	2.450

Art.57B2 PLUS

Code	Kg	LIST PRICE €	SPECIAL PRICE €
8.57.B20100	155	2.075	1.850
8.57.B20110	241	2.608	2.300
8.57.B20120	216	2.556	2.250
8.57.B20130	232	2.974	2.550
8.57.B20140	325	3.293	2.650

A One integral G30 cast iron casting milled with double stressrelieving heat treatment. Wall thickness 43-45mm. Tolerance+12 / -5 mm

B Rough casting with machined and hand scraped base face for direct clamping on Japanese standard pallet.Base with 4 precision holes Ø20F7 and bottom threads M16 with precise pitch dimensions for the use of our Zero Point or to be interface with other pallets or head plates. Ready for installation and to be machined for reset with machine axis. Tolerance +12 / -5 mm

C Cube completely finished with wall thickness roughly 38-40mm. Tolerance ± 0,02 mm

B2 PLUS 1mm overstock on each side. Ready for installation and to be machined for reset with machine axis.

E Integral cube with calibrated holes and solid threads. Tolerance ± 0,02 mm

F Integral cube with hardened bushing 100 Cr6 and stainless steelheli-coils. Tolerance ± 0,02 mm

INTEGRAL VISE-CUBE WITH BASE PLATE

Art.53B1

Light Cube Finished Base

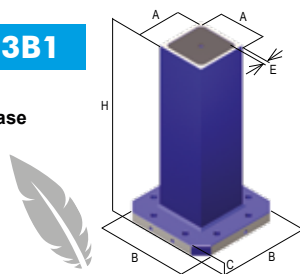

REDUCTION UP TO
20%

Art.55B1

2 sides tombstones light Finished Base

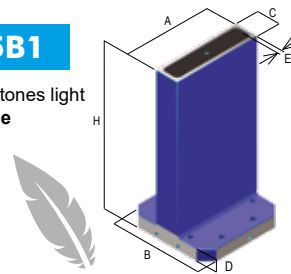

REDUCTION UP TO
20%

A	B	C	E	H	Kg	Code	LIST PRICE €	SPECIAL PRICE €
210	400	45	25	750	167	8.53.B10055	1.853	1.500
260	400	45	25	850	229	8.53.B10085	2.235	1.800
260	500	45	25	750	234	8.53.B10105	2.439	1.950
360	500	50	30	900	400	8.53.B10182	3.453	2.700
360	630	45	30	950	468	8.53.B10185	4.135	3.250
460	630	45	35	950	634	8.53.B10205	5.161	4.250

E= Wall tickness

A	B	C	D	E	H	Kg	Code	LIST PRICE €	SPECIAL PRICE €
410	400	110	55	25	750	193	8.55.B10045	2.111	1.700
410	400	160	55	25	850	239	8.55.B10050	2.343	1.900
510	500	160	55	25	750	277	8.55.B10053	2.757	2.200
510	500	210	55	30	900	402	8.55.B10085	3.531	2.800
640	630	210	55	30	950	553	8.55.B10172	4.753	3.700

E= Wall tickness

ZERO POINT Units & plates

Set up times reduced of 90%, repeatability within 0,005 mm - Ideal for vertical & horizontal machining centres

THE CLASSIC MULTIPLE PNEUMATIC

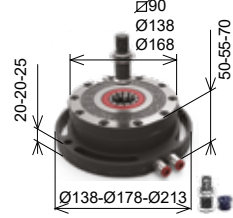

Art.664		WITH FLANGE			
Type	Code	kN	Double Effect kN	LIST PRICE €	SPECIAL PRICE €
1	9.66.41000	5,4	NOT AVAILABLE	632	499
2	9.66.42000	10	NOT AVAILABLE	951	599
3	9.66.43000	16	NOT AVAILABLE	1.194	999



Art.665		BUILT-IN			
Type	Code	kN	Double Effect kN	LIST PRICE €	SPECIAL PRICE €
1	9.66.51000	5,4	NOT AVAILABLE	509	399
2	9.66.52000	10	NOT AVAILABLE	826	499
3	9.66.53000	16	NOT AVAILABLE	1.075	899

THE HERMETIC SINGLE PNEUMATIC

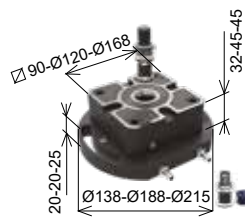

Art.664S		WITH FLANGE		DOUBLE EFFECT AIR+SPRINGS	
Type	Code	kN	Double Effect kN	LIST PRICE €	SPECIAL PRICE €
1	9.66.4S100	5,4	12,7	732	599
2	9.66.4S200	10	27	1.037	699
3	9.66.4S300	16	40	1.194	999

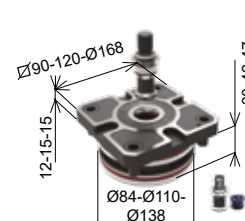

Art.665S		BUILT-IN		DOUBLE EFFECT AIR+SPRINGS	
Type	Code	kN	Double Effect kN	LIST PRICE €	SPECIAL PRICE €
1	9.66.5S100	5,4	12,7	610	499
2	9.66.5S200	10	27	914	599
3	9.66.5S300	16	40	1.075	899

Standard Equipment: 1 pull-stud Art.11A, 1 Teflon cup with O-Ring Art.9

Clamping force 5 ÷ 40 kN / Holding force more than 60 kN / Pneumatic release 6 ÷ 14 bar / Axial and radial compensation thanks to elastic integral collet / Double pull-stud centering for Max rigidity / Air cleaning / Only for SINGLE ZERO POINT (S version): 4 KEYWAYS and DOUBLE EFFECT FUNCTION

PNEUMATIC ZERO POINT KIT INTERFACED BASE PLATES

KIT #1 E #2 POSITIONING & LOCKING INCLUDED

KIT #3 E #4 STANDARD POSITIONING & LOCKING INCLUDED, SPECIFIC LOCKING **EXTRA***

KIT #1 VERTICAL CNC

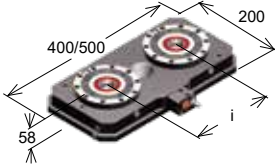

Art.81P BASE PLATE	LIST PRICE €	SPECIAL PRICE €
200x400 (i=200)	2.724	1.749
200x500 (i=250)	2.793	1.849

KIT #2 HORIZONTAL CNC

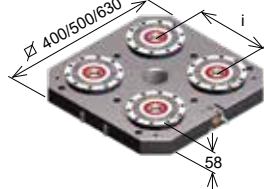

Art.80P BASE PLATE	LIST PRICE €	SPECIAL PRICE €
400x400 (i=200)	4.880	3.299
500x500 (i=250)	5.107	3.499
630x630 (i=300)	5.595	3.999

KIT #3 VERTICAL CNC

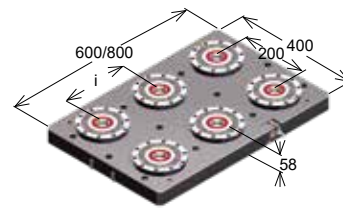

Art.81P BASE PLATE	LIST PRICE €	SPECIAL PRICE €
400x600 (i=200)	7.035	4.699
400x800 (i=300)	7.332	4.899

KIT #4 5TH AXIS CNC

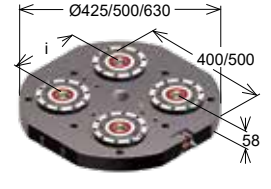

Art.82P ROUND BASE PLATE	LIST PRICE €	SPECIAL PRICE €
Ø425 (i=200)	5.107	3.399
Ø500 (i=250)	5.085	3.499
Ø630 (i=300)	5.674	3.999

INTERFACE PLATES FOR ZERO POINT BASE PLATES

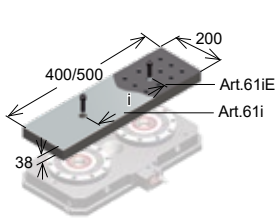

Art.61iC SMOOTH	LIST PRICE €	SPECIAL PRICE €
200x400 (i=200)	936	599
200x500 (i=250)	1.006	649

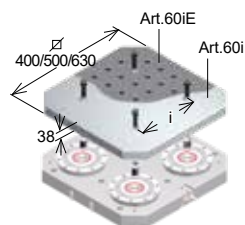

Art.60iC SMOOTH	LIST PRICE €	SPECIAL PRICE €
400x400 (i=200)	1.146	863
500x500 (i=250)	1.380	1.039
630x630 (i=300)	1.730	1.303

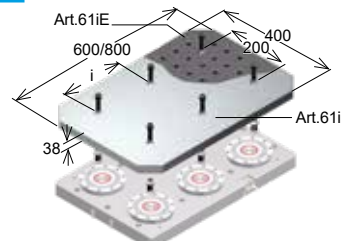

Art.61iC SMOOTH	LIST PRICE €	SPECIAL PRICE €
400x600 (i=200)	1.753	1.320
400x800 (i=300)	2.337	1.760

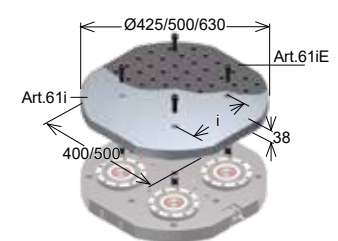

Art.62iC SMOOTH	LIST PRICE €	SPECIAL PRICE €
Ø425 (i=200)	1.228	924
Ø500 (i=250)	1.402	1.056
Ø630 (i=300)	1.636	1.232

Art.61iE INTEGRAL GRID	LIST PRICE €	SPECIAL PRICE €
200x400 (i=200)	1.135	649
200x500 (i=250)	1.250	749

Art.60iE INTEGRAL GRID	LIST PRICE €	SPECIAL PRICE €
400x400 (i=200)	1.505	1.040
500x500 (i=250)	1.968	1.360
630x630 (i=300)	3.090	2.136

Art.61iE INTEGRAL GRID	LIST PRICE €	SPECIAL PRICE €
400x600 (i=200)	2.083	1.440
400x800 (i=300)	2.962	2.048

Art.62iE INTEGRAL GRID	LIST PRICE €	SPECIAL PRICE €
Ø425 (i=200)	1.505	1.040
Ø500 (i=250)	1.921	1.328
Ø630 (i=300)	2.569	1.776

GRIP MATIC Vises

Hydraulic or pneumatic vise double effect - Ideal for 5 axis machining centres

Art.670

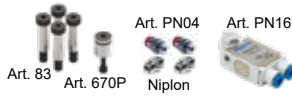

Standard equipment: - 4x Calibrated screws (Art.83) - Centering pin (Art.670P)
- 2 Niplon o 2 Art.PN04 - No return valve (Art.PN16)



Vise base pneumatic or Hydraulic, ideal for 5 axis machining centres.

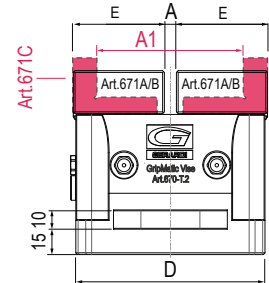
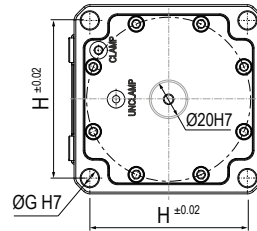
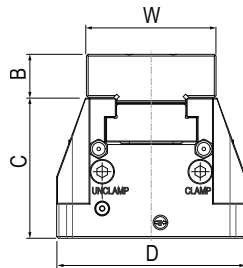

Type	Jaw width W	Min opening A	Max opening A1	Vise height C+B	Base height C	Base length D	Jaw length E	Pitch centering and fixing holes H	Pneumatic		Hydraulic		LIST PRICE €	SPECIAL PRICE €		
									Air pressure	Clamping force	ART.670 Pneumatic Code	Pressure			Clamping force	ART.670 Hydraulic Code
2	74	6,4	88,9	105	80	106	52	90	Max 10BAR	7 kN	7.67.0PN20	30BAR	19 kN	7.67.0ID20	1.790	1.400
3	99	8,5	130,2	135	105	166	78	140		14,4 kN	7.67.0PN30	30BAR	37,5 kN	7.67.0ID30	2.387	1.850
4	124	12	162	165	130	206	96	170		16,9 kN	7.67.0PN40	25 BAR	47 kN	7.67.0ID40	3.162	2.400



Art.671A
Soft Jaw



Art.671B
Soft narrow jaw

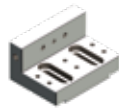

Art.671C
Jaw for narrow width standard jaw plates



Art.243
Hardened grooved straight jaw plate



Art.245
Hardened smooth straight jaw plate



Art.247G
Straight plate with GRIP inserts

INTERFACED PLATE FOR GRIP MATIC VISES - IDEAL FOR 5 AXIS MACHINING CENTRES

Art.670CP SEMI-AUTOMATIC

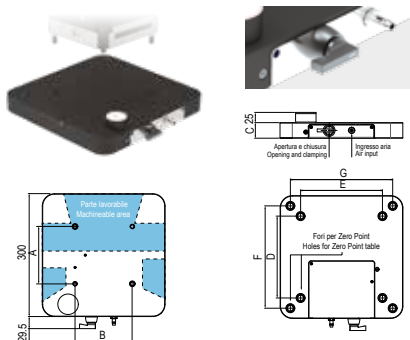

Interface plate for GripMatic vise Art.670PN semi-automatic quick coupling air input and manual system control through a selector.

Type	Holes pitch A	Holes pitch B	Plate height C	Pitch holes (Zero Point) D	Pitch holes (Zero Point) E	Pitch holes (Zero Point) F	Pitch holes (Zero Point) G	Air pressure	Clamping force	Code	LIST PRICE €
2	90	90	38	200	200	250	250	Max 10BAR	7 kN	7.67.0CP20	2.271
3	140	140	38	200	200	250	250		14,4 kN	7.67.0CP30	2.271
4	170	170	38	200	200	250	250		16,9 kN	7.67.0CP40	2.271

Art.670AP AUTOMATIC



Interface plate for GripMatic vise Art.670PN automatic with air input through the machine table and possible to be controlled directly by the CNC. This plate can be fully tailored according the characteristics of the machine (workpiece positioning check and cleanliness).

* Minimum price, PERSONALIZATION INCLUDED

100% CUSTOMIZABLE PLATE

Type	Air pressure	Clamping force	ART.670 Pneumatic Code	LIST PRICE €*
2	Max 10BAR	7 kN	7.67.0AP20	2.497
3		14,4 kN	7.67.0AP30	2.497
4		16,9 kN	7.67.0AP40	2.497

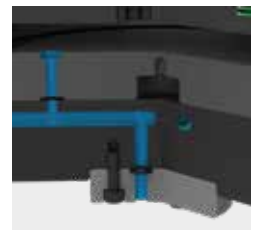

DUODUX

The italian double guide self-centering chuck



DIN
6350

Standard equipment: 1 set made by 3 internal clamp jaws, 1 set made by 3 external clamp jaws, 1 chuck wrench for jaws opening

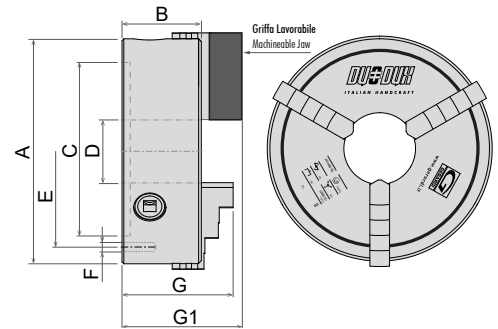
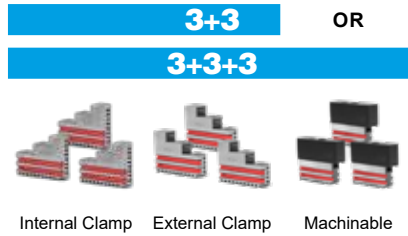

	A	B	C h6	D	E	F	G	G1	daN	Rpm
SINGLE GUIDE	Ø160	70,5	130	42	144,5	N°3 M8	89,5	106	3.100	Max 3.600
DOUBLE GUIDE	Ø200	81	160	53	176	N°3 M10	113	132,5	3.700	Max 3.000
DOUBLE GUIDE	Ø250	88,5	200	80	224	N°6 M12	124	149,5	4.600	Max 2.500
DOUBLE GUIDE	Ø310	100,5	260	108	286	N°3 M12	143,5	162,5	5.500	Max 2.000
DOUBLE GUIDE	Ø365	105,5	310	126,5	336,5	N°6 M14	155	168	5.900	Max 1.800
DOUBLE GUIDE	Ø430	114	382	170	405	N°6 M14	170	176,5	6.900	Max 1.400

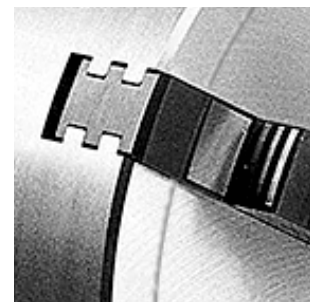

3+3					3+3+3				
	A	Kg	Code	LIST PRICE €	SPECIAL PRICE €	Kg	Code	LIST PRICE €	SPECIAL PRICE €
SINGLE GUIDE	Ø160	8	GMD-160-3G20	1.067	854	10	GMD-160-3G30	1.333	1.067
DOUBLE GUIDE	Ø200	15	GDD-200-3G20	1.156	925	18	GDD-200-3G30	1.444	1.156
DOUBLE GUIDE	Ø250	23	GDD-250-3G20	1.358	1.086	27	GDD-250-3G30	1.650	1.320
DOUBLE GUIDE	Ø310	38	GDD-310-3G20	1.984	1.588	44	GDD-310-3G30	2.319	1.855
DOUBLE GUIDE	Ø365	61	GDD-365-3G20	3.092	2.474	71	GDD-365-3G30	3.760	3.008
DOUBLE GUIDE	Ø430	92	GDD-430-3G20	4.345	3.476	103	GDD-430-3G30	5.180	4.144



ACCURACY, RIGIDITY & STABILITY ALSO DURING HEAVY DUTY MACHINING

DUO-DUX, the double guide self-centering manual chuck 100% Made in Italy. It is made with double guided integral jaws, which can stand heavier charges and grant a better stability. The crown is ground with a special way studied by Gerardi to grant highest precision and repeatability. Every DUO-DUX chuck is balanced following the ISO3089/74 rules and supplied with the warranty and testing certificates. The chucks with diameter 365 and 430mm, suitable for heavy-duty machinings, keep the same technical features and precision of the chucks with lower diameters.

HIGHEST RIGIDITY

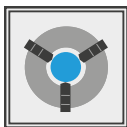

5 YEARS GUARANTEED



IRON CAST BODY



Special model
Ø270-105

Not only standard dimensions: a special Ø270mm version with increased bar holder Ø105 is available too.

Code GDD-270-3G20-105



Integral Jaws

Integral clamping jaws are made of hardened nichel-chrome steel for the highest accuracy and repeatability.



Double guide

Double guide system of our Duo Dux self-centering vises can bear higher workload and grant a higher stability.



5 Years Warranty

Sure of the reliability and high quality of all self-centering vises DuoDux components, we recognize 5 years warranty on the whole range.

STATIC Tool holders

Save purchasing static tool holders - choose from a wide range on the catalogue



SCAN THE QR CODE AND CHOOSE FROM A WIDE RANGE ON THE CATALOGUE

DIN 69880

DMG MORI

Mazak

LOKUMA

BMT

Bolt Mounted Turret



Nakamura-Tome



TSUGAMI CORPORATION

Ask the password to your supplier

EXAMPLE KIT 1

3 PCS

REDUCTION UP TO
10%

PURCHASING 3 STATIC TOOLS

DMG MORI

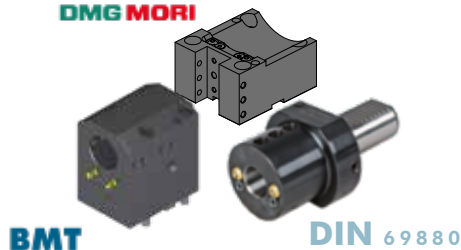

EXAMPLE KIT 2

4 PCS

REDUCTION UP TO
15%

PURCHASING 4 STATIC TOOLS

DMG MORI

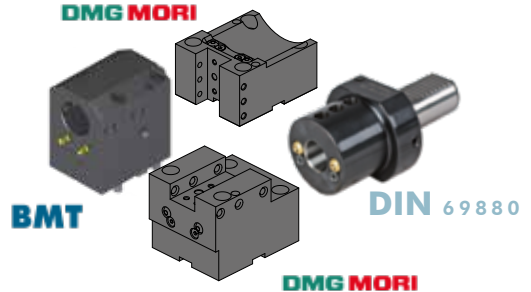

Universal quick change ADAPTORS

New types 2.0 - Compatible with all er outputs

REDUCTION UP TO
50%

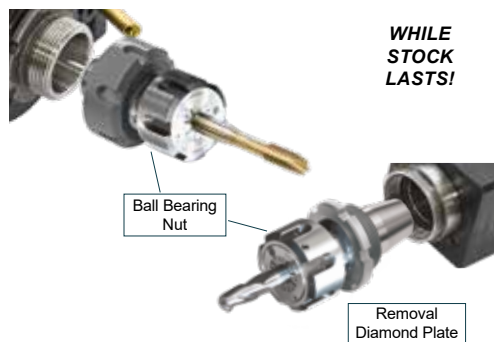

WHILE
STOCK
LASTS!

PATENDED

REMOVABLE DIAMOND PLATE



PRICE LIST 425€ EACH

- Reduce set-up time and possibility of offline tool presetting
- Universal HIGH TORQUE modular quick change adaptor
- Modular toolholder system suitable for every Driven Tool ER collet output.
- Guaranteed higher rigidity and performances on Gerardi driven tools thanks to the removable diamond plate and the ball bearing nut
- All modular quick change 2.0 adaptors are suitable for ER toolholder with external and internal coolant supply
- Using the quick change adaptors, we suggest not to exceed 10.000 Rpm

3 PCS

PURCHASING
3 UNIVERSAL QUICK CHANGES
(INTERNAL OR EXTERNAL NUTS)



KIT1

REDUCTION UP TO
20%

4 PCS

PURCHASING
4 UNIVERSAL QUICK CHANGES
(INTERNAL OR EXTERNAL NUTS)



KIT2

REDUCTION UP TO
25%

WOOW

PURCHASING 1 DRIVEN TOOL, OUTPUT
ER25, ER32 o ER40
1 QUICK CHANGE ADAPTOR OF YOUR CHOICE
(INTERNAL OR EXTERNAL NUTS)



KIT3

REDUCTION UP TO
50%

On the Quick
Change

DRIVEN Tool holders

Driven tools for cnc lathes - Upgrade your lathe and boost productivity!

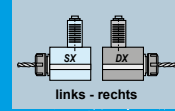

BMT

Bolt Mounted Turret

COMPATIBLE WITH

DOOSAN / HARDINGE / SAMSUNG / HWACHEON / HYUNDAI WIA / VICTOR / HAAS

BMT 65 ALSO COMPATIBLE WITH HAAS LATHES!



80 BAR

Axial

BMT	Code	ER	H Max	Nm Rpm	LIST PRICE €	SPECIAL PRICE €
45	99.DS.A03	25	57,2	35 8000	1.033	839
	99.DS.A04	25	57,2	35 8000	1.179	929
55	99.DS.A01	25	57,2	40 8000	1.363	899
	99.DS.A02	25	57,2	40 8000	1.243	979
65 HAAS READY!	99.DS.A41	32	72,5	70 6000	1.274	1.049
	99.DS.A42	32	72,5	70 6000	1.465	1.179
75	99.DS.A34	40	90,2	100 6000	1.497	1.249
	99.DS.A35	40	90,2	100 6000	1.720	1.399



80 BAR

Radial

BMT	Code	ER	H	Nm Rpm	LIST PRICE €	SPECIAL PRICE €
45	99.DS.A07C	25	65	35 8000	1.822	1.499
	99.DS.A08C	25	65	35 8000	2.190	1.799
55	99.DS.A11C	25	70	40 8000	2.038	1.599
	99.DS.A12C	25	70	40 8000	2.408	1.899
65 HAAS READY!	99.DS.A51C	32	72	70 6000	2.140	1.699
	99.DS.A52C	32	72	70 6000	2.534	1.999
75	99.DS.A38C	40	60	100 6000	3.311	2.649
	99.DS.A39C	40	60	100 6000	3.973	3.099



80 BAR

Adjustable

BMT	Code	ER	H	Nm Rpm	LIST PRICE €	SPECIAL PRICE €
45	99.DS.A16	20	65	15 8000	4.698	3.899
	99.DS.A17	20	65	15 8000	6.111	4.699
55	99.DS.A23	20	65	15 8000	4.698	3.899
	99.DS.A66	20	65	15 8000	6.111	4.699
65 HAAS READY!	99.DS.A64	25	75	25 6000	5.221	4.299
	99.DS.A65	25	75	25 6000	6.748	5.199
75	99.DS.A47	25	75	25 6000	5.221	4.299
	99.DS.A48	25	75	25 6000	6.748	5.199

Both direction of rotation to machine spindle available

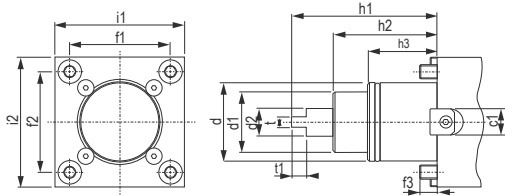

BMT	c1	d	d1	d2	f1	f2	f3	h1	h2	h3	i1	i2	t	t2	h4	N	ØM
45	15	Ø45	35	14	58	58	10	84	60	40	75	75	6	8,5	-	-	-
55	15	Ø55	40	16	64	64	14	104	75	30	85	85	8	8,5	9,5	8	29
65	18	Ø65	45	18	70	73	15	112	83	32	94	94	10	14	15	10	29
75	25	Ø75	55	23	90	90	15	110	80	43	112	112	14	15	-	-	-
85	25	Ø85	65	33,5	100	100	18	140	100	43	125	125	16	20	-	-	-

Bigger Tenon

SPECIAL OFFER ON THE NEW RANGE OF DRIVEN TOOLS

Mazak QTN3

QUICK TURN NEXUS QTN
300 / 350 / 400 / 450 -
SQT 28 / 30 - 300

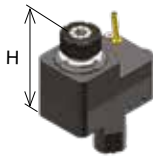

80 BAR

Off-set Axis

Code	ER	H	Nm Rpm	LIST PRICE €	SPECIAL PRICE €
99.MZ.A71	40	145	100 4000	3.320	3.100
99.MZ.A72	40	145	100 4000	3.631	3.300

Mazak QTN2

12 Positions
QUICK TURN NEXUS
QTN 200 / 250
SUPER QUADREX TURN
SQT 15/18 - 200 / 250

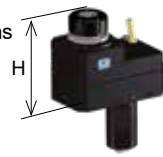

80 BAR

Code	ER	H	Nm Rpm	LIST PRICE €	SPECIAL PRICE €
99.MZ.A58	32	120	80 6000	2.491	1.549
99.MZ.A59	32	120	80 6000	3.010	2.100

Mazak SMART QTS1

- BMT68
QUICK TURN SMART
QTS 100M / 200M
QT COMPACT 100M -
200M - 300M



80 BAR

Code	ER	H	Nm Rpm	LIST PRICE €	SPECIAL PRICE €
99.MZ.A03	32	70	60 6000	1.972	1.749
99.MZ.A06	32	70	60 6000	2.387	2.149

Radial



80 BAR

Code	ER	H	Nm Rpm	LIST PRICE €	SPECIAL PRICE €
99.MZ.A75	40	160	100 4000	3.424	3.200
99.MZ.A81	40	160	100 4000	3.943	3.600



80 BAR

Code	ER	H	Nm Rpm	LIST PRICE €	SPECIAL PRICE €
99.MZ.A65	32	130	80 6000	2.698	1.649
99.MZ.A66	32	130	80 6000	2.906	1.949



80 BAR

Code	ER	H	Nm Rpm	LIST PRICE €	SPECIAL PRICE €
99.MZ.A09	32	80	60 6000	2.698	2.299
99.MZ.A10	32	80	60 6000	2.906	2.599

Direction of rotation opposite to machine spindle

Direction of rotation opposite to machine spindle

DRIVEN Tool holders

Driven tools for cnc lathes - Upgrade your lathe and boost productivity!

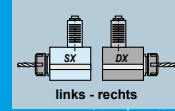

VDI 40

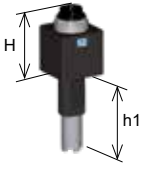

Code	ER	H	h1	Nm	Rpm	LIST PRICE €	SPECIAL PRICE €
99.HA.590082	32	75	117,5	63	6000	945	749
99.HA.590082B	32	75	117,5	63	6000	1.179	899
99.HA.590083	32	75	104,8	63	6000	945	749
99.HA.590083B	32	75	104,8	63	6000	1.179	899
99.HA.596352	32	75	130,25	63	6000	945	749
99.HA.596352B	32	75	130,25	63	6000	1.179	899

Direction of rotation same as machine spindle



* Interchangeable couplings for any type of Haas turret

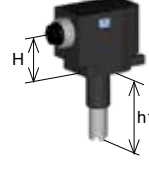

Code	ER	H	h1	Nm	Rpm	LIST PRICE €	SPECIAL PRICE €
99.HA.590084	32	75	117,5	63	6000	1.773	1.349
99.HA.590084B	32	75	117,5	63	6000	2.240	1.699
99.HA.590085	32	75	104,8	63	6000	1.773	1.349
99.HA.590085B	32	75	104,8	63	6000	2.240	1.699
99.HA.596353	32	75	130,25	63	6000	1.773	1.349
99.HA.596353B	32	75	130,25	63	6000	2.240	1.699

Direction of rotation same as machine spindle



Ø45: WT100 -TW1 Ø54: WT100 -TW1



d1	Code	ER	H Max	Nm	Rpm	LIST PRICE €	SPECIAL PRICE €
45	99.MY.A02	25	57,6	35	6000	853	749
	99.MY.A03	25	57,6	35	6000	1.022	899
54	99.MY.A09	32	79,4	60	6000	993	849
	99.MY.A10	32	79,4	60	6000	1.140	949
45	99.MY.A05	25	65	35	6000	1.506	1.249
	99.MY.A06	25	65	35	6000	2.456	1.649
54	99.MY.A11	32	75	60	6000	1.868	1.549
	99.MY.A12	32	75	60	6000	2.207	1.849

Direction of rotation opposite to machine spindle



BMT44 WT100 -TW1 BMT55 SUPER NTJ-NTJX/NTM 3/TMC 18/ TW10/SC150-250/WT150-250/WTM 150/WTS 150/WT100

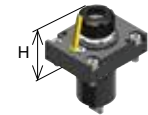

d1	Code	ER	H Max	Nm	Rpm	LIST PRICE €	SPECIAL PRICE €
45	99.NK.A40	25	57,2	40	6000	946	799
	99.NK.A43	25	57,2	40	6000	1.081	899
55	99.NK.A03	32	72,2	63	6000	993	849
	99.NK.A04	32	72,2	63	6000	1.530	1.299
45	99.NK.A50	25	60	40	6000	1.676	1.399
	99.NK.A53	25	60	40	6000	2.008	1.699
55	99.NK.A13	32	55	63	6000	1.868	1.549
	99.NK.A14	32	55	63	6000	2.519	2.099

Direction of rotation same as machine spindle



BMT60: SPACE TURN LB 200EX/LB 2500EX/LB3000EX/GENOS SERIES L300-MW/ MULTUS U3000/U4000T/LU3000EX M/MY



d1	Code	ER	H Max	Nm	Rpm	LIST PRICE €	SPECIAL PRICE €
60	99.OK.A80	32	79	60	6000	1.687	1.299
	99.OK.A81	32	79	60	6000	2.141	1.599

Direction of rotation same as machine spindle



60	99.OK.A82	32	70	60	6000	3.048	2.299
	99.OK.A83	32	70	60	6000	3.631	2.749

Direction of rotation opposite to machine spindle



VDI40 OKUMA CAPTAIN L370 M - ES L10 M - GENOS L300, L3000-E M/MY (VDI40) LB 300 MW - LB/LU 300 MY - LB/LU 300, 3000 M (VDI40)



Axial



Code	ER	H	Nm	Rpm	LIST PRICE €	SPECIAL PRICE €
99.OK.A18	32	98,6	70	6000	1.947	1.499
99.OK.A23	32	98,6	70	6000	2.465	1.899

Radial

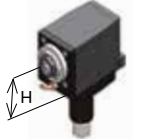

99.OK.A19	32	70	60	6000	3.373	2.549
99.OK.A25	32	70	60	6000	4.151	3.149



BMT60 EX 380 / 310 / 508 / 510 / 708 / 710 / 910 - EX 2000 M/Y - TC 350 MC - TT 350 MC - NEX 108/110/908/910 - LA 200/250 M/Y - LA 250 YS (15 stations) - FX 800 - MX 800 - VTL 450 M - LX 2500 M/Y



Axial

Code	ER	H	Nm	Rpm	LIST PRICE €	SPECIAL PRICE €
99.TK.A12	32	93	50	6000	1.499	1.149
99.TK.A13	32	93	50	6000	2.213	1.699

Radial

99.TK.A02	32	90	50	6000	3.139	2.399
99.TK.A05	32	90	50	6000	3.333	2.549



BMT65: M06D/M06SD/M06SY/M08SD/M08SY



Code	ER	H Max	Nm	Rpm	LIST PRICE €	SPECIAL PRICE €
99.TS.A01	25	60	40	8000	1.558	1.199
99.TS.A02	25	60	40	8000	2.141	1.649



99.TS.A08	25	65	40	8000	2.529	1.949
99.TS.A09	25	65	40	8000	3.112	2.449

ANGLE HEADS & SPINDLE Speeders

New! Now also classic line angle heads at a special price !!



STANDARD EQUIPMENT

Special bag / Stop block / ER nut /
Wrenches / Grease tube /
Instruction book

Go to page
of catalogue to
find out more



**STOP BLOCK
INCLUDED**

STD 90°
SERIES



Ratio
1:1



Rpm
8.000



Kg 5.4



ER25
Ø1/16

CLASSIC LINE ATC

G90-16

List Price ~~€ 3.598~~
Special Price: **€ 3.000**

STANDARD EQUIPMENT

Special bag / Stop block / ER
nut / Wrenches / Grease tube /
Instruction book

Go to page
of catalogue to
find out more



**STOP BLOCK
INCLUDED**

STD 90°
SERIES



Ratio
1:1



Rpm
4.000



Kg 11



ER32
Ø2/20

CLASSIC LINE ATC

G90-20

List Price ~~€ 3.604~~
Special Price: **€ 3.200**

WIDE RANGE OF ANGLE HEADS
almost 200 types of classic
angle heads available

MAXIMUM RIGIDITY
thank to te integral shank &
shaft made in one solid piece

360° ADJUSTABLE BODY
maximum rigidity and cor-
rosion resistant. Minimum
thermal expansion

ABEC 9 BALL BEARINGS
pre-loaded angular contact
bearings with Long Life grea-
se lubrication

GLEASON GEARS
ensure less warming and
noise and the highest Rpm

STANDARD EQUIPMENT

Special bag / Stop block / ER nut /
Wrenches / Grease tube /
Instruction book

Go to page
of catalogue to
find out more



**STOP BLOCK
INCLUDED**

STD 90°
SERIES



Ratio
1:1



Rpm
5.000



ISO /BT 40
Kg 7
ISO /BT 50
Kg 12



ER32
Ø2/20

EVOLUTION LINE ATC

F90-20S

List Price ~~€ 3.749~~
Prezzo Speciale: **€ 3.000**

INTERCHANGEABLE SHANKS
Interchangeable driven tapers to fit
any machine spindle. One head for
many machines

STEEL HEAD BODY
Treated steel head body with 360°
position and internal air pressure, ma-
ximum rigidity and corrosion resistant

STANDARD EQUIPMENT

Special bag / Stop block / ER nut /
Wrenches / Grease tube /
Instruction book

Go to page
of catalogue to
find out more



SPINDLE SPEEDERS



**STOP BLOCK
INCLUDED**

GSP
SERIES



Ratio
1:8



Rpm
24.000
output
3.000
input



Kw 8



Nm 9,5



ISO /BT 40
Kg 6
ISO /BT 50
Kg 8,5



Ø 13



ER20
Ø1/13



N 413

EVOLUTION LINE

GSP 13

List Price ~~€ 3.632~~
Prezzo Speciale: **€ 3.000**

EVEN FASTER
Speed increased
of +30%
for the whole range

INTERNAL REFRIGERATION
internal refrigeration available on the
entire range with pressure
up to 70bar